

PARAGON ONE SLIDE CONTROL Owner's Book

INCLUDES USER, INSTALLATION & MAINTENANCE
INSTRUCTIONS

**Please read these instructions carefully before you start using the
appliance**

Keep this booklet handy for future reference

**This appliance is
for use in GREAT BRITAIN or IRELAND only**

A QUALITY PRODUCT FROM PARAGON FIRES

CONTENTS

	PAGE
User Instructions	3
SECTION ONE Introduction	3
Consumer Protection.....	3
Health and Safety.....	3
Introduction.....	3
SECTION TWO Operation	4
SECTION THREE Fuel Bed Cleaning and Layout	5
Coal Layout.....	5
Pebble Layout.....	7
SECTION FOUR Important information	10
INSTALLATION INSTRUCTIONS	11
SECTION FIVE Specification	11
SECTION SIX Regulations and Warnings	11
SECTION SEVEN Siting the Appliance	12
Class One.....	12
Class Two Fabricated Metal.....	13
SECTION EIGHT Fireplace Requirements	13
Clearance to Shelf.....	13
Clearance to Side of Fire.....	14
Ventilation.....	14
SECTION NINE To Install the Appliance	14
Examine Flue /Chimney.....	14
Connecting to the Gas Supply.....	14
Preparing the Appliance for Gas Connection.....	15
Gas Connection from the Front.....	16
Fixing Fire into Opening.....	16
Optional Cable Fixing System.....	16
Checking Gas Soundness.....	17
Connecting Control Lever.....	17
Checking Operation of Fire.....	18
Checking Product Clearance.....	18
Completion of Installation.....	18
Advise Customer That.....	18
MAINTENANCE INSTRUCTIONS	19
SECTION TEN Maintenance	19
General.....	19
Fuel Bed Cleaning.....	19
Pilot Linting.....	19
Replacement of Gas Control.....	19
Replacement of Burner and or Silencer.....	20
Replacement of Injector.....	20
Replacement of Pilot Assembly.....	20

PARAGON ONE SLIDE CONTROL Users Instructions

SECTION ONE Introduction

Consumer Protection Information

As manufacturers and suppliers of heating products, we take every care, as far as is reasonably practicable, that these products are so designed and constructed as to meet the general safety requirement when properly used and installed. To this end, our products are thoroughly tested and examined before despatch.

IMPORTANT NOTICE: Any alteration that is not approved by the appliance manufacturer could invalidate the approval of the appliance, operation of the warranty and could affect your statutory rights.

Health and Safety Notice

Important

This appliance could contain some of the materials, indicated below, that could be interpreted as being injurious to health and safety. It is the users / installers responsibility to ensure that the necessary personal protective clothing is worn when handling these materials, see below for information.

Artificial Fuels, Mineral Wool, Insulation Material, Refractory/Ceramic Fibres, Glass Yarn - may be harmful if inhaled, may be irritating to skin, eyes, nose and throat.

When handling avoid inhaling and contact with skin or eyes. Use disposable gloves, facemasks and eye protection. After handling wash hands and other exposed parts. If a vacuum is used for cleaning the fuel bed or cleaning after servicing / installation it is recommended that it be of the type fitted with a HEPA filter.

Disposal of refractory/ceramic materials. To keep dust to a minimum these materials should be securely wrapped in polythene and be clearly labelled 'RCF waste'. These materials are not classified as 'hazardous waste and should be disposed of at a site licensed for the disposal of industrial waste.

INTRODUCTION

The PARAGON ONE SLIDE CONTROL is a decorative fuel effect appliance with a radiant heat conserver box for improved efficiency.

The PARAGON ONE SLIDE CONTROL is designed and tested to the requirements of EN 509

The PARAGON ONE SLIDE CONTROL should be installed and serviced by a competent person i.e. CORGI-registered, in accordance with the current Gas Safety (Installation and Use) Regulations 1998 (as amended).

The chimney or flue (unless new) must be swept before installation if it has been used for solid fuel or oil.

PARAGON ONE SLIDE CONTROL Users Instructions

SECTION ONE Introduction Continued

The PARAGON ONE SLIDE CONTROL incorporates a single gas control, which selects ignition pilot, and main burner low and high settings.

The PARAGON ONE SLIDE CONTROL incorporates a safety device in the form of an Oxygen Depletion System, which constantly monitors the oxygen in the room and will cause the fire to switch off if the oxygen level reduces, for instance due to insufficient ventilation or a blocked flue.

If this repeatedly occurs do not attempt to relight the appliance until a qualified engineer has checked it, the problem may not be due to lack of air or a defective flue.

Warning:-This appliance has a naked flame, has with all such fires it is essential that a fireguard should be used for the protection of children, the elderly and infirm. Fireguards should conform to BS 6539 (1984) (Fireguards for use with solid fuel appliances).

During the normal operation of the fire some black staining may appear on some parts of the fuel bed. This is quite normal and adds to the appearance of the appliance. However, if excessive black staining does occur it may be due to the fuel bed being incorrectly laid. This should be checked prior to contacting a service engineer.

SECTION TWO Operation

The full lighting procedure is as follows: -

- a. Push slide control lever down, as far as possible a clicking noise will be heard and the pilot will light, **HOLD DOWN FIRMLY FOR ABOUT 20 SECONDS.**
- b. Allow the lever to spring up the pilot light should remain alight and the main burner should light on its low setting.
- c. Should the pilot fail to light, pull the lever fully up to turn off the appliance, wait 3 minutes and repeat the procedure (a &b). If the pilot does not light and no clicking noise is heard replace the battery and try again.
- d. After lighting the pilot flame and the main burner on its low setting the control lever may be lifted until slight resistance is felt, this will put the burner on its high setting.
- e. To completely extinguish the fire, pull the lever up past the resistance to its fullest extent.
- f. The fire may be operated on either its low or high setting.
- g. It is recommended that the appliance is operated on its high setting for a short period before adjusting to the low setting.
- h. If the ignition does not operate fit a new 9V battery (PP3/MN1602) to the ignition unit, located behind the fret adjacent to the gas inlet pipe, and repeat ignition procedure prior to reporting a fault.

Note: -If the ignition fails the pilot can be lit with a taper or a match held at the pilot head.

PARAGON ONE SLIDE CONTROL Users Instructions

SECTION THREE Fuel Bed Cleaning and Layout

Important: - Refer to the 'Health & Safety Notice located on page 3 of this booklet before cleaning or replacing any refractory material.

The fuel bed components are delicate and they should be handled with great care. The loose parts may be removed for cleaning. They can be brushed very gently with a soft brush to remove dust or any deposits. A vacuum cleaner may only be used after the loose components and moulded shapes have been removed.

CARE SHOULD BE TAKEN TO AVOID CONTACT WITH THE REFRACTORY LINING THIS IS A DELICATE SURFACE AND SHOULD **NOT** BE WIPED OR RUBBED. _

FUEL BED LAYOUT (COAL OPTION)

Coal set provided consists of :-

- 9 off shape 'A' coals
- 12 off shape 'B' coals
- 1 off Left hand front coal matrix
- 1 off Right hand front coal matrix
- 1 off Base coal matrix

IMPORTANT: Keep the coals in separate groups for laying on the fire bed.

- Place the left and right hand front coals onto the front of the burner tray as shown. The front coals must be put on first because the left hand coal is retained in place by the base matrix.
- Place the base matrix behind the front coals as shown.
- Pay special attention to make sure that the burner slot is completely clear as shown below.



PARAGON ONE Users Instructions

SECTION THREE Fuel Bed Cleaning and Layout Cont.

- Place the first row of 3 x A and 3 x B overlay loose coals as shown between the front coals and base matrix. Make sure that they are stable and DO NOT let them fall down in the gaps between the peaks on the matrix.

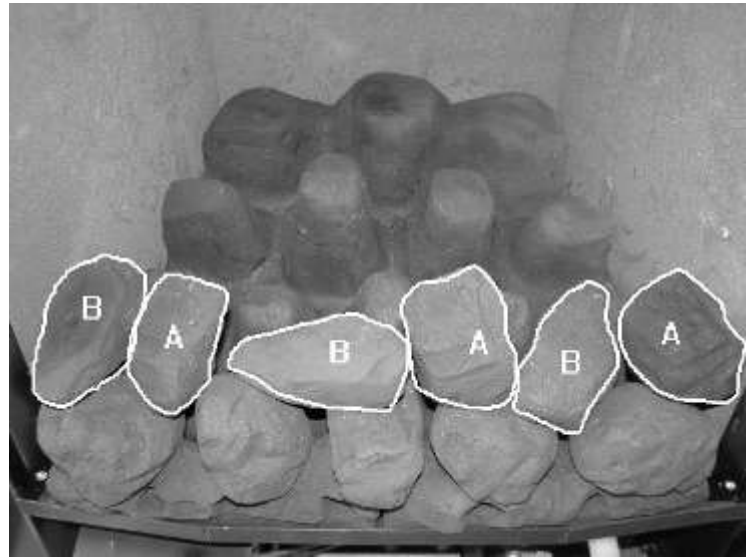

- Add the second row of 3 x A and 2 x B loose coals on to the matrix, resting against the previously placed row of coals and the base matrix. DO NOT allow the coals to fall down the gaps between the matrix peaks.

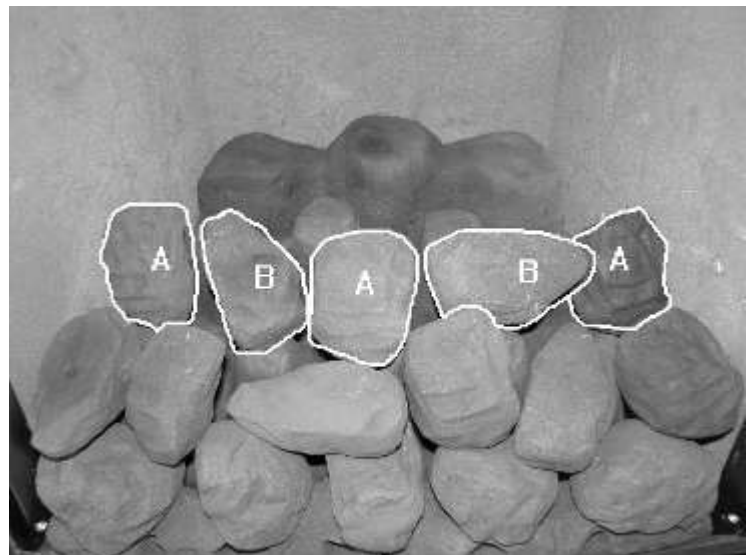

- Add a third row of 2 x A coals and 3 x B coals. DO NOT allow the coals to fall down the gaps between the matrix peaks.

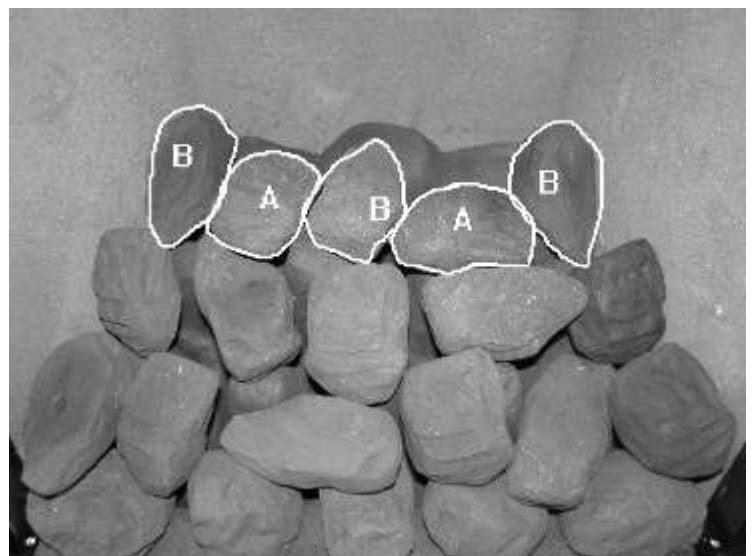

PARAGON ONE Users Instructions

SECTION THREE Fuel Bed Cleaning and Layout Cont.

- Add 2 x type B coals at the rear of the coal matrix as shown.

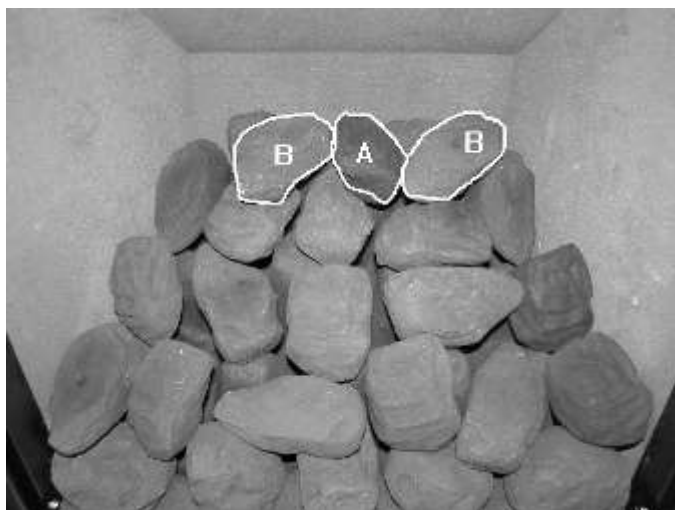

- Add the final 2 x B and 1 x A coals as shown to the top of the coal bed. Arrange so as to be stable. The layout is now finished.

Note: Dye is available for touching up coal and liner-board surfaces where the black colouring may have rubbed off in use.

FUEL BED LAYOUT (PEBBLE OPTION)

FUEL BED COMPONENTS

- 1 off Left hand front pebble matrix
- 1 off Right hand front pebble matrix
- 1 off Base matrix (black)
- 15 loose overlay pebbles as per the guide below (note, qty of each colour may vary):

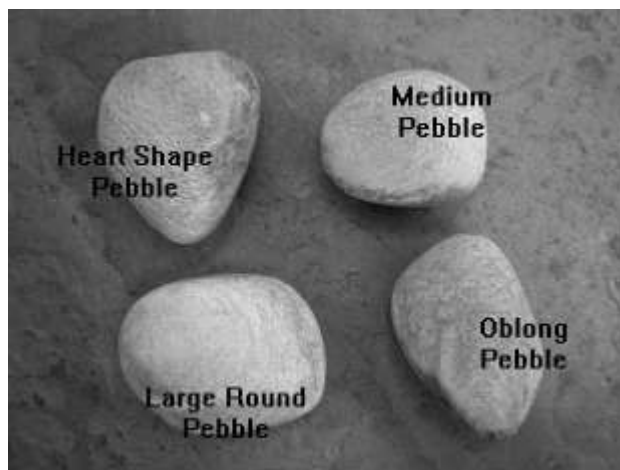

Pebble identification	Pebble qty	
	Brown	Grey
Large Round Pebble	1	4
Heart Shape Pebble	3	1
Medium Pebble	1	3
Oblong Pebble	1	1
Total	6	9

PARAGON ONE Users Instructions

SECTION THREE Fuel Bed Cleaning and Layout Cont.

PEBBLE LAYOUT

WARNING

Take great care when positioning the pebbles to avoid marking the black linings.

Before fitting pebble set, loosen burner securing screws and make sure that burner is pushed to the right side of the burner tray. That will ensure maximum aeration to the burner reducing any discolouration of the light pebbles.

- Place the front pebble matrixes in place on the front of the burner tray. Then place the main base matrix in place which will secure the LH front pebble matrix in place. Make sure that the burner slot remains visible as per the photograph below.

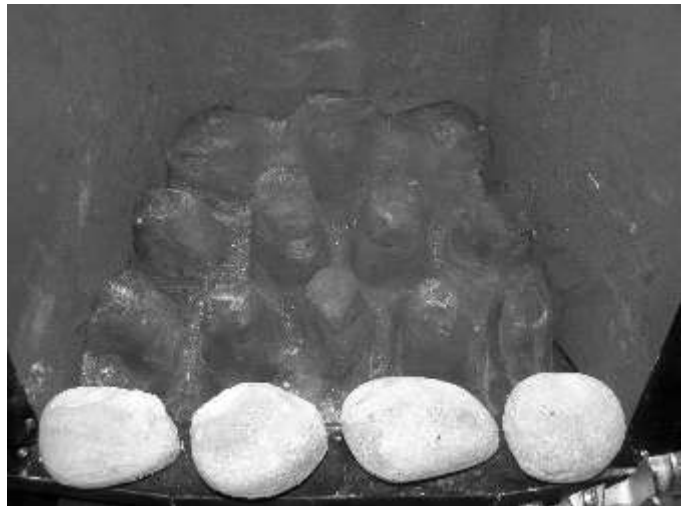

- Place the front row of pebbles as shown placed bridged between the cut outs on the front pebble matrixes and the base matrix as shown. The sequence is (L to R) Large round, Oblong, Large round, Medium pebble, Large round. Shapes must be as shown but colours may be chosen to suit personal preference.

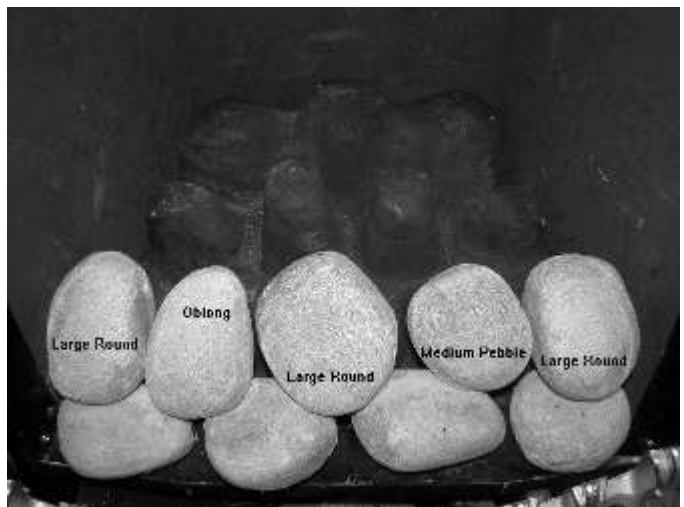

- Place the back row of three medium pebbles as shown.

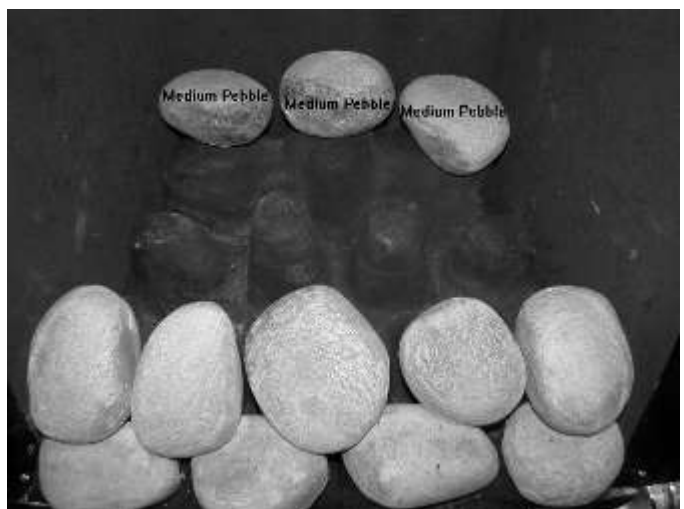

PARAGON ONE Users Instructions

SECTION THREE Fuel Bed Cleaning and Layout Cont.

- Place two heart shaped pebbles as shown on the second row of pebbles. Rest them carefully on the side liners and base matrix touching the first row laid earlier.

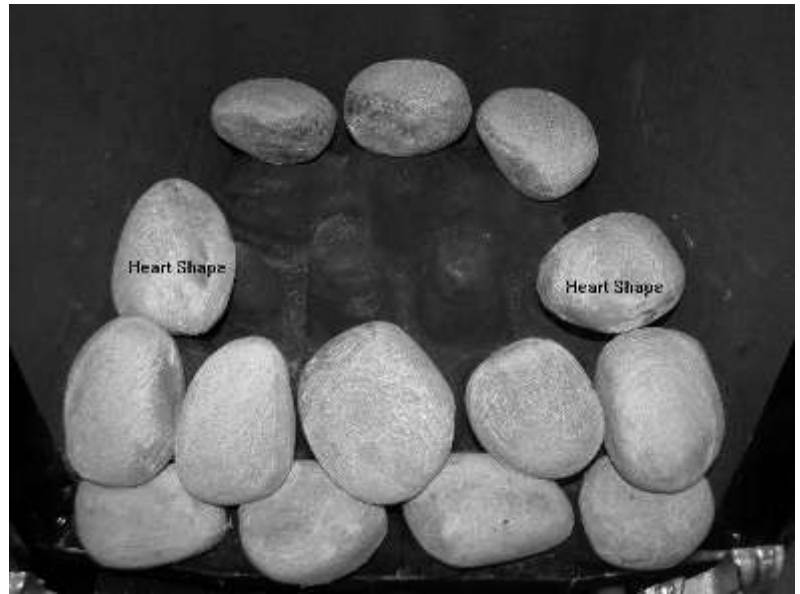

- Place the third row of heart shape, large round and oblong pebbles as shown, resting on their edge on the base matrix and against the back row already placed.

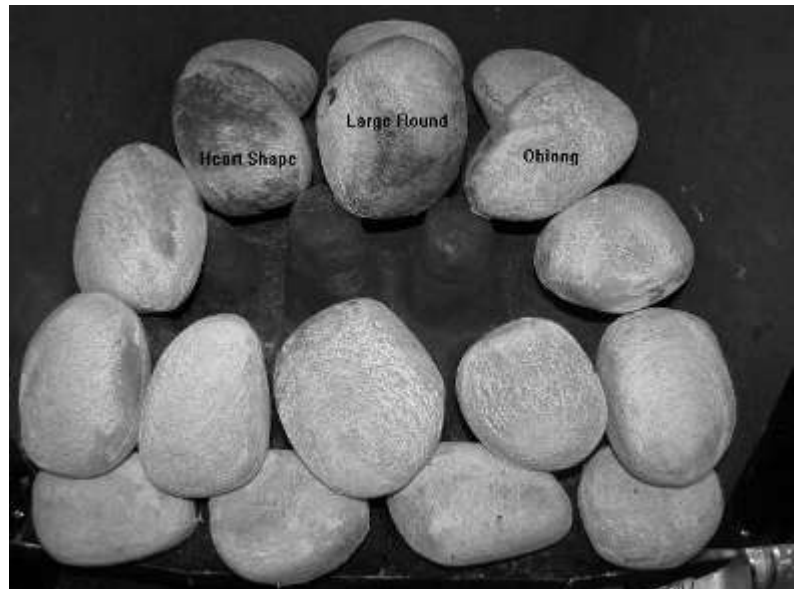

- Place the final large round pebble and heart shape pebble in the remaining positions on the second row. Place the front edges touching the base matrix and the back edges against the third row of pebbles already laid.
- Check all pebbles are securely positioned. Do not let them drop into the gaps between the peaks on the base matrix. If in doubt rotate and re-position



PARAGON ONE Users Instructions

SECTION FOUR Important Information

The only user removable parts are: -

- The loose pebbles or coals.
- The baseboards
- Cast Fret
- Decorative Trim

Like all appliances incorporating an aerated burner a low frequency noise may be heard, particularly on the low setting, this is quite normal and does not affect the operation of the appliance.

Servicing

It is advised that the PARAGON ONE fire is serviced annually this is more likely to provide trouble-free operation. A competent person must carry this out, i.e. CORGI Registered Installer in accordance with the current Gas Safety (Installation and Use) Regulations 1998 (as amended).

The chimney or flue should be checked annually to ensure clearance of combustion products.

Ventilation in the United Kingdom

This appliance does not normally require purpose-built ventilation but if for any special reason purpose-built ventilation is provided it should be checked periodically to ensure freedom from obstruction.

Ventilation in the Republic of Ireland

Must be permanent ventilation and must comply with the rules in force and should be checked periodically to ensure freedom from obstruction.

General Appliance Care

Any debris from the chimney or flue should be removed from the fuel bed. The fire should be allowed to cool for three to four hours before removing debris.

Rubbish must not be thrown onto the fuel bed under any circumstances. The cast fire front must be positioned in front of the fire whilst it is burning.

Fret (Fire Front)

A Fret must be used with this appliance, and must conform too: -

- It must be made from non-combustible material.
- Its general construction should enable it to stand firmly across the full width of the burner.
- The design of the fire front (fret) must have a removable ashtray cover (lower section).
- The ash tray cover must have cut-outs and or holes which provide ventilation to the underside of the burner.

The effective area of ventilation through the ash tray cover must be greater than 1365mm² (2.12 sq. ins.).

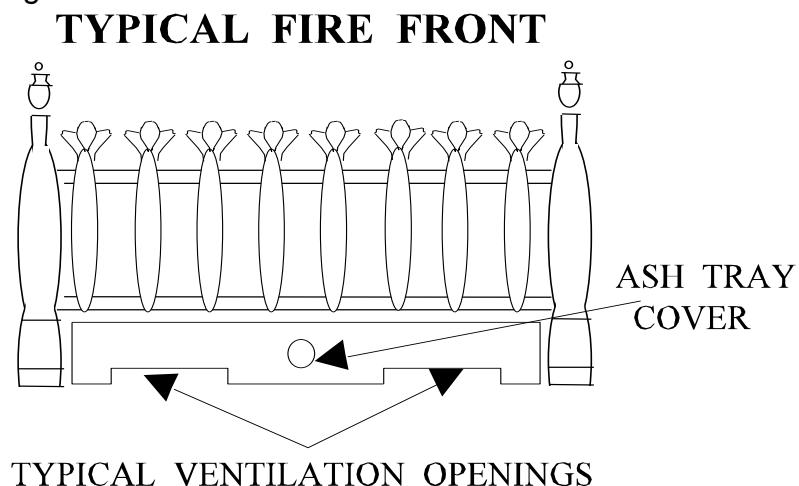

PARAGON ONE SLIDE CONTROL Installation Instructions

SECTION FIVE Specification

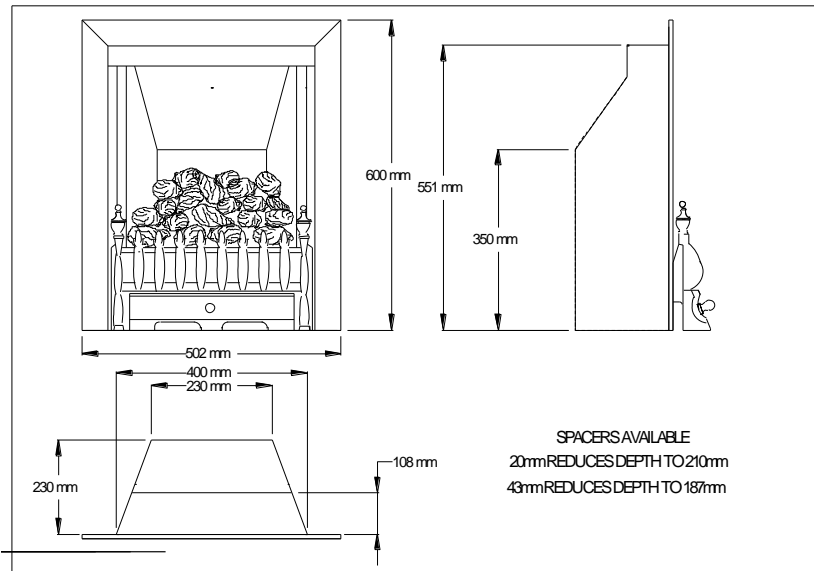

Category of Appliance:.....B_{AS}
Category I_{2H}
Gas type:.....G20
Gas Pressure:.....20 mbar
Gas input high:.....6.70 kW Gross
Gas input low:.....2.40 kW Gross
Injector Main:.....Size 460
Oxy-pilot.....SIT9040
Data Label Location:.....Frame of appliance on top RH corner behind trim
Gas Connection:.....8 mm OD Tube

NOTE: The efficiency of this appliance has been measured as specified in BS7977-1 2002 and the result is 40.8%. The gross calorific value of the fuel has been used for this efficiency calculation. GasTec have certified the test data from which it has been calculated. The efficiency value may be used in the UK Government's Standard Assessment Procedure (SAP) for energy rating of dwellings.

SECTION SIX Regulations and Warnings

- THIS APPLIANCE MUST ONLY BE INSTALLED IN THE GB OR IRELAND.
- Only to be used in sufficiently ventilated room. Read instructions carefully before installation and use. The appliance must be installed by a competent person, i.e.. CORGI Registered Installer in accordance with the current Gas Safety (Installation and Use) Regulations 1998 (as amended). Failure to do so could lead to prosecution.
- This PARAGON ONE SLIDE CONTROL is for use ONLY with the GAS STATED ON THE DATA BADGE.

CHECK YOU HAVE THE CORRECT APPLIANCE FOR THE GAS YOU ARE USING.

- It can be used in conjunction with the following chimneys: -
- A conventional brick or stone chimney,
- A metal flue and box conforming to BS 715, further details are covered in later text.
- A non-combustible hearth must be provided to comply with the building regulations or a suitable proprietary fire surround with a 100 degrees C rating.
- During initial firing an odour may be evident. This is the binder used during the manufacture of the fibre components and there are no harmful effects produced.

PARAGON ONE SLIDE CONTROL Installation Instructions

SECTION SIX Regulations and Warnings Continued

The following are the relevant Codes of Practice and British Standards: -

BS 5871

BS 8303 1986

BS 5440 part 1 1990

BS 1251 1987

BS 6891 1988

BS 6461 parts 1 & 2 1984

BS 715 1989

BS 1289 part 1 & 2 1986

Note:- This appliance must be installed to current versions of the above standards and include any relevant amendments.

The Building Regulations issued by the Department of the Environment

The Building Standards (Scotland) (Consolidation) Regulations issued by the Scottish Development Office.

SECTION SEVEN Siting the Appliance

The fire can be installed in the following flues and locations: -

• CLASS ONE

A conventional brick or stone chimney as used for a solid fuel appliance with a typical effective cross-sectional dimension of 225 x 225 mm (9 x 9 ins) or a lined flue with a minimum diameter of 125 mm (5 ins)

Note: The restrictor plate (fitted to the fire) may be left upright in flues of 175mm (7") or greater. This being subject to satisfactory products clearance.

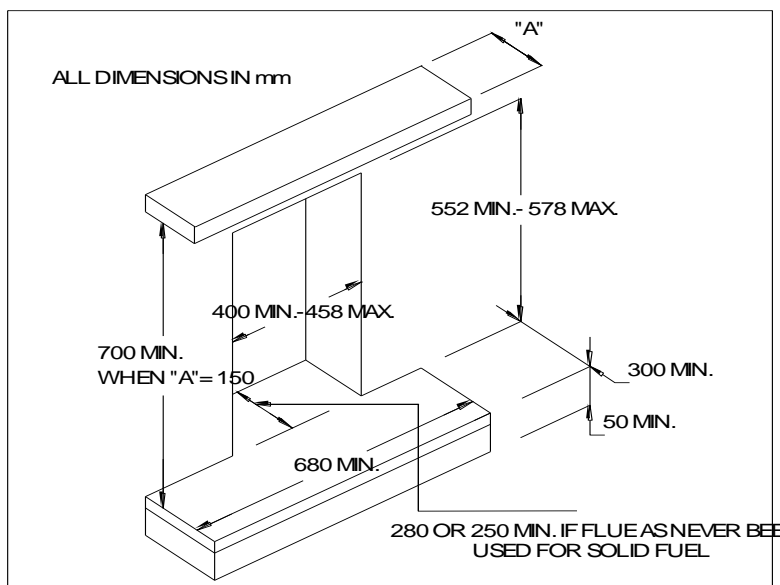

Fireplace opening must be 552 mm - 578 mm high by 400 mm - 435 mm wide (or up to 458 mm if the cable fixing system is used).

The opening depth must be a minimum of 280 mm to allow sufficient volume for debris collection (this depth may be reduced to 250 mm if the chimney is new or has never been used for solid fuel or oil before).

To obtain this depth it may be necessary to remove the chairbrick.

Note: spacers are available in 20mm and 43mm to further reduce the opening depth if required (if a spacer is used then the thickness of the

spacer must be added to the minimum 300mm hearth depth to comply with regulations.

Any permanent flue restriction or variable dampers are to be removed or locked fully open.

The chimney should be swept prior to installation if not new.

PARAGON ONE SLIDE CONTROL Installation Instructions

SECTION SEVEN Siting the Appliance Continued

• CLASS TWO FABRICATED METAL

A double-walled or insulated metal flue box built to the requirements of BS 715 with an insulated flue having a minimum diameter of 125 mm (5 ins) and a minimum effective overall height of 3 metres (10 ft).

IMPORTANT: - the flue restrictor plate must be bent down when the appliance is installed in this type of flue.

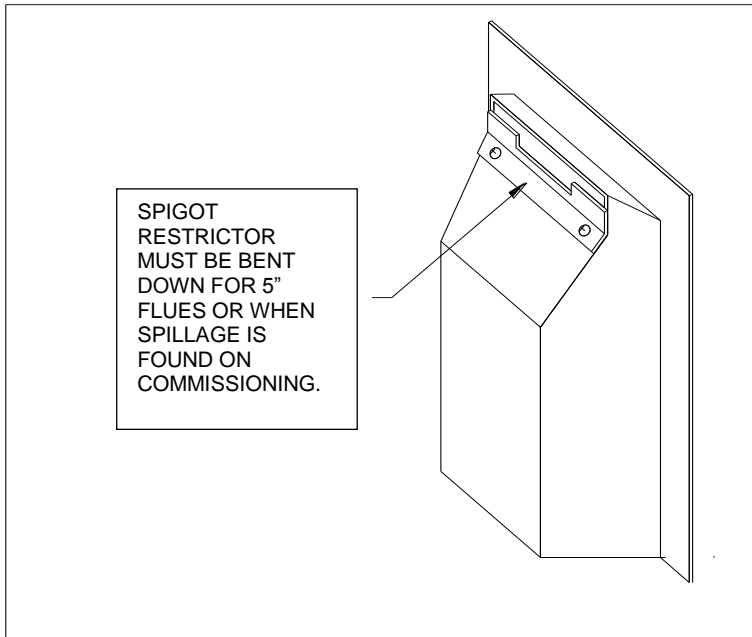

Note: A brick or stone chimney with a 125 mm (5 ins) minimum diameter flue liner conforming to BS 715 may be used. Provided a suitable sealing plate is fitted to the base of the liner and the appliance does not restrict the opening into the liner.

Note: Dampers or register plates must not restrict any of the above flues. The flue must only service a single appliance and not have any branches or traps, which may impede the natural draught. If a terminal is fitted it must be suitable for the purpose.

SECTION EIGHT Fireplace Requirements

A flat face of 605 mm high x 500 mm wide must be provided around the fireplace opening for the fixing of the appliance to ensure that a good seal is formed. The base of the fire opening must be flat to ensure sound fixing of the appliance.

A non-combustible hearth must be provided beneath the appliance within the fireplace opening, a fire-resisting hearth must also be provided symmetrically disposed about the fireplace opening a minimum thickness of 12 mm with the perimeter 50mm above floor level. The width must extend a minimum of 150 mm either side of the fireplace opening and a depth of 300 mm (+ thickness of spacer if a spacer is used).

Purpose-built superimposed fire-resistant hearths and back panels, specified as suitable by the manufacturers, may be used, or a suitable proprietary fire surround with a 100°C rating.

CLEARANCE TO SHELF

Minimum clearance from hearth to underside of combustible shelf should be 700mm provided shelf depth 150mm or less. This height may be reduced to 640mm for a shelf depth of 100mm or less

When the shelf depth is increased by increments of 12.5 mm greater than 150mm, add 25mm to the 700mm minimum clearance.

PARAGON ONE SC Installation Instructions

SECTION EIGHT Fireplace Requirements Continued

Hole in the Wall Installation

Please read these instructions carefully if you intend an installation without a hearth.

This appliance must be installed in accordance with all relevant sections of approved document “J” of the building regulations

It is recommended that a non combustible hearth extends a minimum of 300mm forward of the fire opening and a minimum of 150mm either side, and that a rise exist at the front edge and sides of the hearth of a minimum of 50mm.

The fire may be installed so that its base sits on a surface of a fire opening at least 105 mm up from the floor (*this is to ensure that no flame or incandescent material is less than 225mm above the floor, a requirement of approved document “J”*). Where this is the case a means must be provided to support the fret this may typically be met with a small projecting hearth of minimum 100mm. Unless the fret is fixed to the appliance or is an integral part of the fascia of the appliance.

Consideration should be given to the location of the appliance ensuring it is very visible and it should be positioned at a height were it can clearly be seen on approach.

Frets, and Fascias used for HOLE in the WALL must be compliant with C&J Fires CE approval; these are listed at the end of this page.

Where the fire is fitted as a “Hole in the Wall” without a hearth the installer MUST ensure the appliance is fixed firmly into the opening to ensure no movement takes place to the fuel bed when the appliance controls are operated.

The installer MUST ensure that the fuel bed is laid correctly and securely

The installer MUST advise the user that care should be taken when the appliance is in use to ensure occupants **do not** get unnecessarily close to the appliance or position furniture or other appliances to close.

The installer MUST remind user of the requirement to fit a “secure fireguard” where the room is used by elderly, infirm or young persons.

The installer MUST explain to the user that the area immediately in front of the appliance must always be keep clear of combustible items other than the floor covering (which must be fixed)

In the case of the Pebble fuel bed an alternative layout for “Hole in the Wall” must be followed refer to page 10 in this Manual, this alternative layout MUST adhered to for ALL HOLE in the WALL installations

List of Approved Fascias
Crystall Fascia

PARAGON ONE SLIDE CONTROL Installation Instructions

SECTION EIGHT Fireplace Requirements Continued

CLEARANCE TO SIDES OF FIRE

Minimum width between vertical sides of combustible surround should not be less than 700mm provided fire is central to surround and sides do not project more than 150 mm. When vertical side forward projection is increased by 12.5 mm add 50 mm to inside width of surround.

N.B. When fire is fitted this provides a minimum side clearance of 100mm.

Care should be taken to prevent any damage being caused to surrounding soft furnishings or decoration, e.g. many embossed vinyl wall coverings may become discoloured if placed too close to the appliance.

VENTILATION

In the **United Kingdom** no special ventilation bricks or vents are required into the room containing the appliance, provided normal adventitious room ventilation exists. The installer must satisfy this point by carrying out a mandatory spillage test.

In the **Republic of Ireland** permanent ventilation must comply with the rules in force

SECTION NINE To Install the Appliance

EXAMINE FLUE / CHIMNEY

Check that the flue/chimney conforms to the required specifications as previously stated. Examine the condition and carry out any remedial work. If the flue/chimney has been used for solid fuel or oil, it should be swept prior to appliance installation. A smoke test must be carried out to check that satisfactory smoke clearance has been established. If all the smoke is not drawn into the flue, pre-heat the flue with a blowtorch or similar and re-check. If there is any uncertainty examine for the cause and, if necessary, seek expert advice.

CONNECTING THE GAS SUPPLY

Determine where the gas supply is to be connected to the appliance. This may be done from the front of the unit from either the left or right side, or a concealed fitting from the rear.

PARAGON ONE SLIDE CONTROL Installation Instructions

SECTION NINE To Install the Appliance Continued

PREPARING THE APPLIANCE FOR A GAS CONNECTION

If it is intended to be a concealed connection the 8mm supply should be positioned in the opening first.

The pipe should be positioned so that when the appliance is pushed back into the opening it enters the grommet hole at least 180mm, taking into account the requirements of BS 6891 1988 dealing with enclosed pipes.

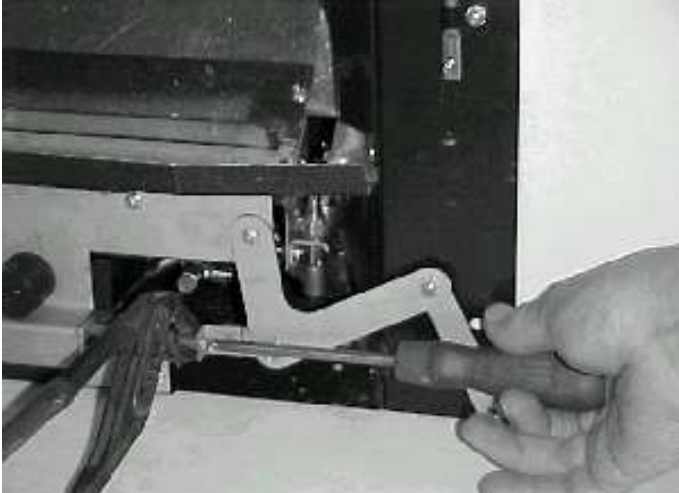

Taking great care grip the copper protective sleeve at the end of the gas control spindle (DO NOT GRIP SPINDLE IN ANY OTHER PLACE) as shown and remove the screw from the end as shown above.

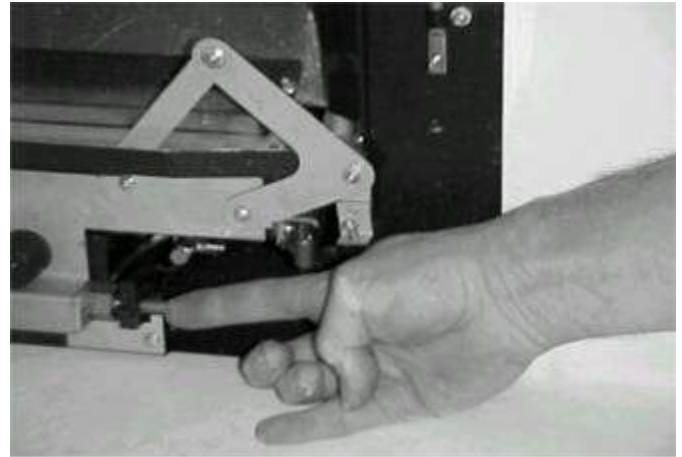

Ensure the spindle is pushed back inside the control valve as far as possible. Ensure the bell crank mechanism is swung up to give easy access to the gas connection point as shown.

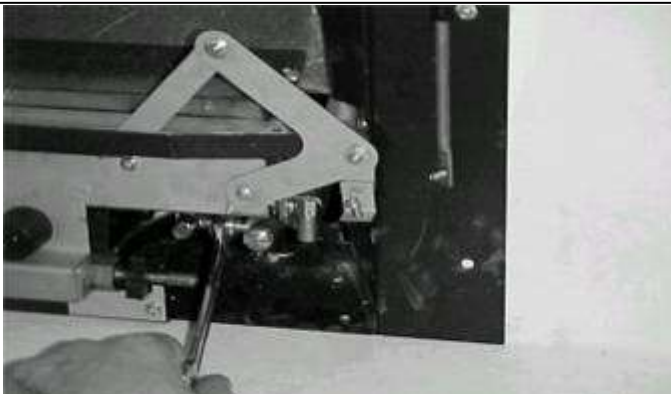

Cut a cross slit in the rubber grommet and feed the appliance onto the 8mm-gas supply pipe. Position the restrictor elbow supplied either as shown or on top of the valve to the left of the inlet elbow using the cutout provided. Make the gas connection and tighten with a spanner taking care not to apply any force to the gas control spindle as above. Ensure the restrictor valve is opened fully and its cap replaced tightly.

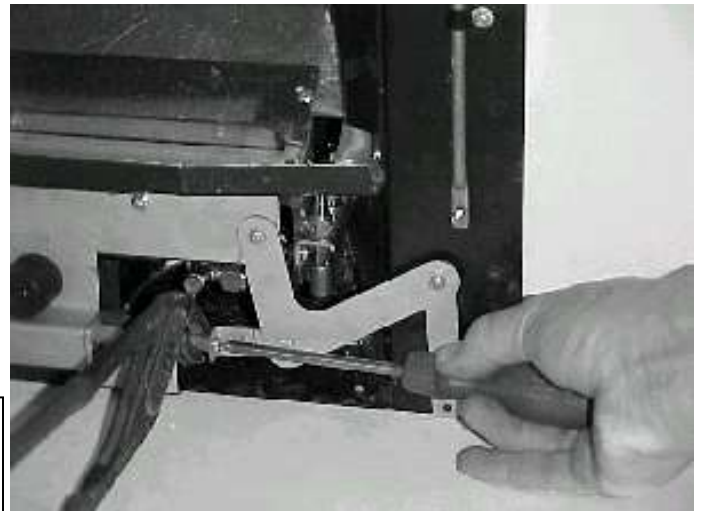

Check for gas soundness. Reconnect the bell crank mechanism as above ensuring that the gas control spindle is gripped only over the protective copper sleeve and no other part of the spindle as, ensure NO side strain is applied to the spindle.

Note: pipe-work in the opening of the fireplace to the rear of the appliance must be suitably wrapped in accordance with the regulations.

PARAGON ONE SLIDE CONTROL Installation Instructions

SECTION NINE To Install the Appliance continued

GAS CONNECTION FROM THE FRONT

Connections may be made from the front of the appliance from either the left, right or centre above the gas valve in 8-mm diameter pipe. If a left-hand connection is required the tube should be routed below the gas control and onto the inlet elbow. The inlet elbows should be rotated to the required position. A suitable isolating cock should always be fitted in the supply feed to the fire to facilitate servicing.

FIXING FIRE INTO OPENING

Remove the paper backing from the length of foam seal and stick it around the rear flange of fire. If a spacer is going to be used stick the second length (supplied with the spacer kit) around the rear face of the spacer unit, THE FOAM SEAL MUST BE POSITIONED TO ENSURE AN AIR TIGHT SEAL WHEN THE APPLIANCE IS FITTED.

NOTE: -DO NOT USE PERMANENT SEALING COMPOUNDS *i.e.* SILICONE SEALANT. THIS COULD CAUSE THE APPLIANCE TO BE DAMAGED WHEN IT IS REMOVED FOR SERVICING, AND COULD INVALIDATE THE WARRANTY.

If a spacer is not being used, mark position of flange hole in the fireplace front drill and fix firebox in position with wall plugs and wood screws. If spacer is being used fix the spacer to the fireplace first with wood screws and wall plugs then screw firebox to spacer box using screws provided.

OPTIONAL CABLE FIXING SYSTEM (Available on request from PARAGON FIRES)

(for use when fixing to 18" openings or when it is desirable not to drill the fireplace fascia) it may **not** be possible to use the cable fixing system with some pre-cast flues.

Drill 4 holes in the rear of the fireplace opening in the position shown and fix securely the 4 eye bolt provided with suitable wall plugs

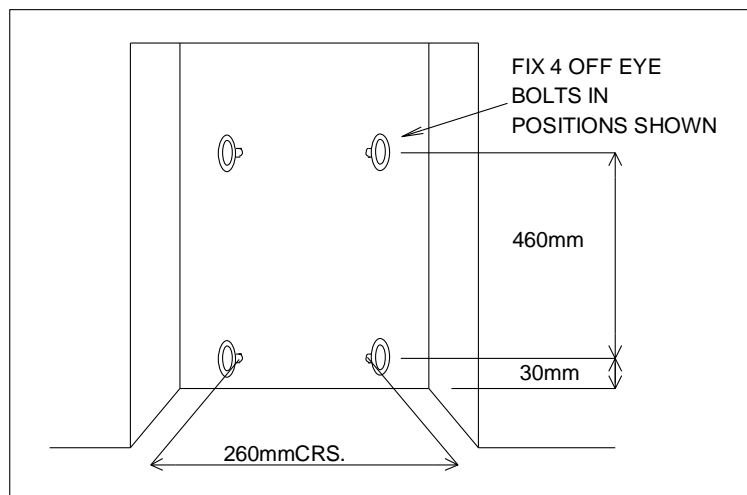

Fix the fire casing back into the opening using the cable fixing system as shown in do not cut off loose ends of cable after fixing, coil and tuck carefully back

Note: when using the cable fixing kit with the spacer, fix and seal the spacer to the rear of the appliance flange with the screws and foam seal provided.

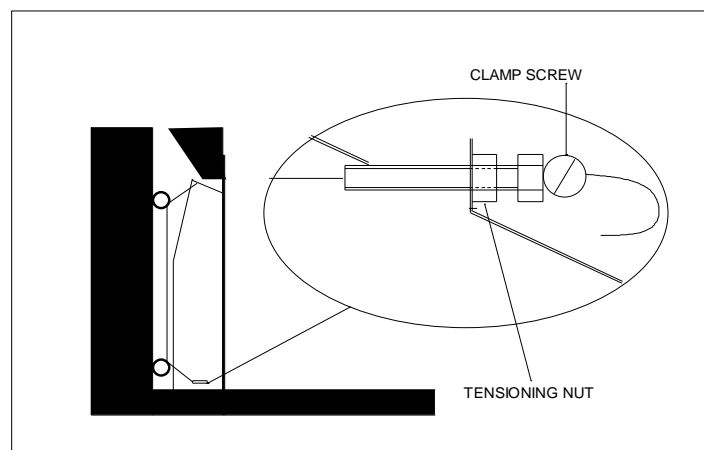

PARAGON ONE SLIDE CONTROL Installation Instructions

SECTION NINE To Install the Appliance Continued

CHECKING GAS SOUNDNESS

After completing the gas connection to the appliance, check for gas soundness in accordance with current codes of practice.

CONNECTING CONTROL LEVER



Flip the slide control lever round so that the rubber-capped end is protruding out to the right as shown in the left-hand picture. Check that it slides freely up and down in the nylon slide guides. Remove the nyloc nut with a 7mm A/F spanner as shown.

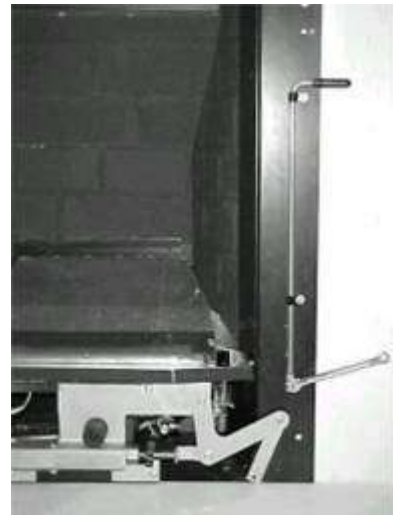

Connect the link lever to the stud at the end of the slide control lever and replace the nylock nut. **IMPORTANT TURN THE NUT UNTIL IT JUST TIGHTENS AND THEN TURN IT BACK A HALF TURN.** Check the operation on the lever and mechanism ensure that the lever springs back to the low position when it is released after pushing down.



FUEL BED LAYOUT

Important: - Refer to the 'Health & Safety Notice located on page 3 of this booklet before cleaning or replacing any refractory material.

Lay fuel bed as shown in the Users Section of these instructions.

ENSURE THE FUEL BED IS PLACED AS INDICATED IN THESE INSTRUCTIONS.

PARAGON ONE SLIDE CONTROL Installation Instructions

SECTION NINE To Install the Appliance Continued

CHECKING OPERATION OF FIRE

Remove the screw from the pressure test point on the inlet elbow and fit pressure gauge. Turn on gas to the appliance. Purge the air from the appliance by holding the control lever down to allow the air in the pipe-work to be purged and the spark generator to ignite the pilot. Check that the electrode is sparking at the gap between the thermocouple tip and the electrode, continue until pilot ignition is established. Raise the control lever to its high position and allow the appliance to run for a period of approximately 5 minutes. Check the inlet pressure is 20 ± 1 mbar for Natural Gas (G20) or 37 ± 1 mbar for Propane Gas (G31).

CHECKING PRODUCT CLEARANCE

Check for satisfactory clearance of combustion products. Close all doors and windows and leave fire burning for 5 minutes. Then position a smoke match just into the top of the fire opening and move it left and right, all the smoke must be drawn into the flue. If spillage occurs, allow a further 5 minutes. Should spillage still occur, remove appliance restrictor plate if still fitted and repeat spillage test. If spillage still occurs turn off the fire and seek expert advice.

If an extractor fan is situated in the room this test should be repeated with the fan running. If there is a connected room with an extractor fan, the test should be repeated with all the doors to that room opened and the extractor fan running.

COMPLETION OF INSTALLATION

Fit the decorative trim with the four magnetic strips placed two on each vertical side flange of the firebox - one at the top and one at the bottom. Offer the decorative trim up squarely and centrally and push back into position. Ensure the positioning of the magnet does not interfere with the operation of the slide control mechanism.

Position a suitable fire fret up to the front of the appliance ensuring that it meets the specification referred to earlier.

Demonstrate the lighting and extinguishing procedures to the user and the removal and refitting of the decorative trim and fret for cleaning.

ADVISE CUSTOMER THAT:

- ❖ This appliance has a naked flame, as with all such fires it is recommended that a fireguard should be used for the protection of children, the elderly and infirm. Fireguards should conform to BS 6539 (1984) (Fireguards for use with solid fuel appliances).
- ❖ The curing effect of heating the fuel bed and other Refractory components will cause an initial odour. This is due to the starch used in the manufacturing process and is non-toxic.
- ❖ Any debris should be cleaned from the appliance. A vacuum cleaner can be used but only after all the loose components have been removed. The appliance should be serviced annually by a competent person in accordance with these instructions and the appliance checked for spillage in accordance with the method detailed in these instructions.

Hand these instructions over to the user.

PARAGON ONE SLIDE CONTROL Maintenance Instructions

SECTION TEN Maintenance Instructions

GENERAL

Servicing should be carried out annually by a competent person such as a CORGI-registered person in accordance with the current Gas Safety (Installation and Use) Regulations 1998 (as amended), this should ensure the safe and correct operation of the appliance.

Before commencing any service or replacement of parts, turn off the gas supply to the fire. After servicing check for gas soundness.

When ordering spare parts please quote appliance name and serial number, these can be found on the data badge, which is located by removing the decorative fire trim.

At least once a year, check for debris in the catchment area behind the fire and in the flue way. If soot has accumulated check, to establish cause, rectify and clean flue or chimney accordingly.

FUEL BED CLEANING

Important: - Refer to the 'Health & Safety Notice located on page 3 of this booklet before cleaning or replacing any refractory material.

The fuel bed components are delicate and they should be handled with great care.

The loose parts and moulded shapes may be removed for cleaning. They can be brushed very gently with a soft brush to remove dust or any deposits. A vacuum cleaner may only be used after the loose components have been removed.

Examine the fuel bed components for signs of cracking and replace if necessary. (IMPORTANT) see fuel bed layout procedure before attempting to replace loose fuel bed components, which should only be replaced as a complete set with no extra components.

PILOT LINTING

Check pilot aeration holes for linting, use a vacuum cleaner nozzle taking care not to damage the pilot head. (This should be done every time the fire is serviced)

REPLACEMENT OF GAS CONTROL

1. Turn off the gas supply by isolating cock.
2. Lift away carefully fire fret.
3. Lift away carefully all loose fuel bed components.
4. Lift away carefully base boards.
5. Disconnect gas supply from inlet elbow of appliance (right of gas control)
6. Undo and remove two lower screws from fixing plate at front of appliance.
7. Undo and remove two screws securing the tray to the back support.
8. Undo the nut at the lower end of the slide control lever and separate it from the link
9. Lift away the appliance burner tray from the main casing.
10. Disconnect the three compression gas connections from the gas control.
11. Undo the thermocouple connection from the rear of the gas control tap.
12. Undo the screw in the centre of the gas control spindle and remove from linkage.
13. Undo and remove the two screws securing the gas control valve to assembly.
14. Service or replace gas control tap as necessary.
15. Re-assemble the in reverse order.
16. Turn on the gas supply, check for soundness and re commission appliance.

PARAGON ONE SLIDE CONTROL Maintenance Instructions

SECTION TEN Maintenance Instructions continued

REPLACEMENT OF BURNER AND OR THE SILENCER

NOTE: The silencer must not be modified and must be correctly positioned in its bracket. The burner can be slid to the right side for a pebble fuel bed to ensure maximum aeration.

1. Repeat operations 1-5 for the removal of the gas control and spark generator.
2. Undo the two screws securing the burner in the top of the main burner tray and remove burner and silencer.
3. Clean, service or replace as necessary.
4. Re-assemble in reverse order.
5. Turn on gas supply, check for gas soundness and re- commission appliance.

REPLACEMENT OF INJECTOR

1. Repeat operations 1-5 for removal of gas control and spark generator
2. Repeat operation 2 for removal of burner and or silencer.
3. Disconnect gas connection to injector and gas control.
4. Unscrew the locking nut fixing injector to mounting bracket.
5. Clean or replace as necessary.
6. Re-assemble in reverse order.
7. Turn on gas supply, check for gas soundness and re- commission appliance.

REPLACEMENT OF OXY-PILOT ASSEMBLY

NOTE: If the pilot assembly is replaced it must be replaced by an identical unit from the same manufacturer and replaced as a complete unit.

1. Repeat operations 1-9 for removal of gas control and spark generator.
2. Disconnect the thermocouple from the gas control tap.
3. Disconnect the gas connection from the pilot assembly.
4. Remove igniter lead from pilot assembly.
5. Undo the two screws securing the oxy-pilot to the burner.
6. Re-assemble the in reverse order.
7. Turn on the gas supply, check for gas soundness and re-commission appliance.

Paragon Fires

Telford
Shropshire
TF3 3AR

Telephone 0845 5195991

Web Site www.charltonandjenrick.co.uk

WARRANTY COVER WARRANTY COVER

Important

For future reference we suggest you record the following details here, and keep the receipt as proof of purchase. This information may be asked for when you contact the helpdesk.

Model: **PARAGON ONE Slide Control** Serial No.

G	X								
---	---	--	--	--	--	--	--	--	--

This information can be found on the label attached to the packaging and on the data badge, which is located on the appliance flange, top right behind trim.

Retailer Name: _____

Address: _____

--	--	--	--	--	--	--	--

 Date of Purchase:

Service Log

The following information must be complete and supported by receipts as part of the conditions of the extended three year parts warranty and the appliance must be registered by completing and returning the registration document (last page of this booklet) to Paragon Fires.

--	--	--	--	--	--	--	--

 Date of First annual service:

Engineer Name _____

Corgi Registration No.

--	--	--	--	--	--	--	--	--	--

--	--	--	--	--	--	--	--

 Date of Second annual service:

Engineer Name _____

Corgi Registration No.

--	--	--	--	--	--	--	--	--	--

We may introduce modifications to products from time to time, and consequently the details given in this booklet are subject to alteration without notice.

Paragon Fires
Telford
Shropshire
TF3 3AR
Telephone 0845 5195991
Web Site www.charltonandjenrick.co.uk

PARAGON ONE

**THIS IS YOUR EXTENDED FIVE YEAR PARTS
WARRANTY**

PLEASE READ IT CAREFULLY AND ENSURE YOUR INSTALLER HAS FILLED IN THE FIRST PORTION, KEEP IT IN A SAFE PLACE SO THAT IT IS AVAILABLE WHEN YOUR CORGI ENGINEER CARRIES OUT THE ANNUAL SERVICE.

THIS IN NO WAY REDUCES YOUR STATUTORY RIGHTS

THE WARRANTY COMMENCES FROM THE DATE OF PURCHASE YOU MUST RETAIN YOUR RECEIPT OR INVOICE AS PROOF OF PURCHASE. THIS EXTENDED WARRANTY SPECIFICALLY EXCLUDES SOFT REFRACTORY COMPONENTS, ANY BULB AND ANY BATTERIES.

Terms and Conditions

1. The appliance must be installed by a CORGI registered person.
2. The appliance must be used in accordance with the users instructions.
3. The appliance must be serviced annually by a CORGI registered person.
4. The service log must be correctly filled out and the record of annual services must be up to date and supported by receipts in each case.
5. This warranty is not transferable and relates to the original installation only.
6. The Registration Form must be correctly filled out and returned.
7. The appliance has not been subjected to misuse or accident or been modified or repaired by any person other than the authorised employee or authorised representative of Charlton and Jenrick Ltd.
8. The registration form must be returned within 3 months of purchase.

PARAGON HELPDESK NUMBER 0845 5195991

PLEASE REGISTER YOUR 12 MONTH WARRANTY WITH US TODAY

Simply detach this sheet from this booklet, complete and return it in a stamped addressed envelope to:

PARAGON FIRES
Charlton and Jenrick Ltd
UNIT D
STAFFORD PARK 2
TELFORD
SHROPSHIRE
TF3 3AR

YOUR DETAILS

Name _____

Address _____

--	--	--	--	--	--	--	--

Post Code TELEPHONE
No.

--	--	--	--	--	--	--	--	--	--	--	--	--	--	--	--

PRODUCT DETAILS

Model: **PARAGON ONE Slide Control** Serial No. **G X** _____

--	--	--	--	--	--	--	--

Date of Purchase

This information can be found on the label attached to the packaging and on the data badge, which is located on the appliance flange, top right behind trim.

WHERE DID YOU PURCHASE THIS PRODUCT

Name _____

Address _____

--	--	--	--	--	--	--	--

Post Code
TELEPHONE No.

--	--	--	--	--	--	--	--	--	--	--	--	--	--	--	--

Paragon One Slide Control Coal

Product ID Label	0903	Serial No Prefix	GX
Fire Box Labels: Restrictor Plate Spillage (Text) Data Badge			
Fire Box Grommet			
Burner Tray / Box Assembly			
Warning Label (Fire Guard)			
Fuel Bed Comprises of: Base Matrix (4720) Bag Oval Coals (4721) Bag Round Coal (4722) Front Coal LH (4723) Front Coal RH (4724)			
Fixing (0705) (includes 4 magnets & foam seal)			
Magnet (4 X 3048)			
Restrictor Elbow (2613)			
Battery 9V (1904)			
Additional Cap			
Owners Book			
ID Label & Packing Labels			
Serial Number			
Inspector			

Paragon One Slide Control Pebble

Product ID Label	0902	Serial No Prefix	GX
Fire Box Labels: Restrictor Plate Spillage (Text) Data Badge			
Fire Box Grommet			
Burner Tray / Box Assembly			
Warning Label (Fire Guard)			
Fuel Bed Comprises of: Base Matrix (4720) Bag Pebbles (4786) Front Coal LH (4784) Front Coal RH (4785)			
Fixing (0705) (includes 4 magnets & foam seal)			
Magnet (4 X 3048)			
Restrictor Elbow (2189)			
Battery 9V (1904)			
Additional Cap			
Owners Book			
ID Label & Packing Labels			
Serial Number			
Inspector			